

REVERSE T









CODE ID

ISLAND HOOD 90

FTIHD 960 TC BK X



-  Auto - Power Off
-  Energy Class
-  Suction
-  Timer
-  Filtering
-  LED Lighting
-  Island Installation

ISLAND HOOD

Energy Class: A

PERFORMANCE

Suction power up to 730 m³ / h
4 suction levels
Auto-off
Filter saturation indicator
Suction operation with
filter predisposition
Sound power from 47 to 72 dBA

FEATURES

Touch controls
LED bar lighting with rear
and front bars
PRO-Baffle professional filter in stainless steel
Minimum air outlet Ø 150 mm

SERIES ACCESSORIES

Power Cord

OPTIONAL ACCESSORIES

FCHF 28: carbon filter for filtering version



STAINLESS STEEL - BLACK GLASS
FTIHD 960 TC BK X

FULGOR MILANO

VENTILATION

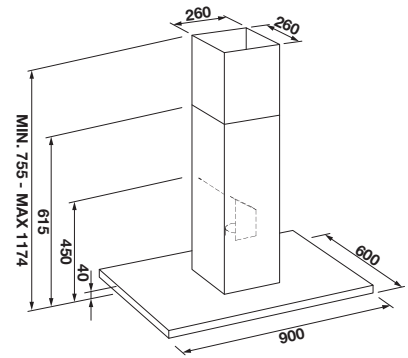

FTIHD 960 TC BK X	
Type	Electronic
Finishing	Stainless steel with black glass insert
Installation	Island
FEATURES	
Energy efficiency class	A
Speed levels	4
Automatic cut-off	• 10 minutes
Grease filter reset warning light	•
Charcoal filter reset warning light	•
Lighting type	LED bar (front - rear)
Grease filters material	Professional baffle in stainless steel
Dishwashable grease filters	•
Ø duct diameter	Ø 150 mm
Non return flap	•
CONTROLS	
Programming non return flap	Touch control
Remote control	•
POWER RATINGS	
Output m ³ /h (max)	730
Sound level (dBA)	47 - 72
Yearly energy consumption (kWh)	49
Motor power (W)	275
Tension and frequency (V-Hz)	220 - 240 / 50
Power cord length (m.)	2
ACCESSORIES	
Motor	•
HP filter for filtering version	FCHF 28
DIMENSIONS	
Width mm	900
Height mm	755 - 1174
Depth mm	600